

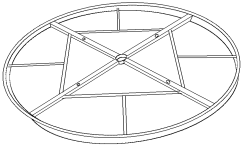



ITEM NAME / NOM D'ITEM : NOE DINING TABLE

ITEM # / NO.ITEM : 703831

PARTS LIST / LISTE DES PIÈCES

(1)	(3)	(4)	
 <p style="text-align: right;">×1</p>	 <p style="text-align: right;">×1</p>	<p>A.  ×4</p> <p>B.  ×4</p> <p>C.  ×1</p>	
<p style="text-align: center;">(2)</p>			
 <p style="text-align: right;">×1</p>			

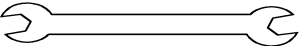
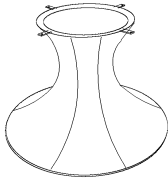
ASSEMBLY INSTRUCTIONS / INSTRUCTIONS D'ASSEMBLAGE

I

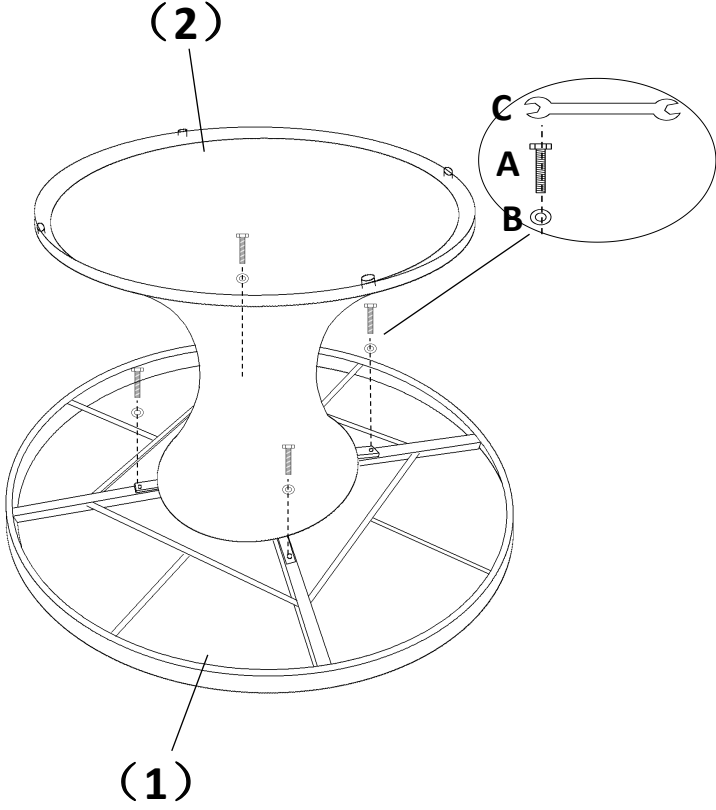

II

